



# LA4440

## Monolithic Linear IC 6W 2-Channel, Bridge 19W(typ) Power Amplifier

ON Semiconductor®

<http://onsemi.com>

### Features

- Built-in 2 channels (dual) enabling use in stereo and bridge amplifier applications.
  - Dual : 6W×2 (typ)
  - Bridge : 19W (typ)
- Minimum number of external parts required.
- Small pop noise at the time of power supply ON/OFF and good starting balance.
- Good ripple rejection : 46dB (typ)
- Good channel separation.
- Small residual noise (Rg=0).
- Low distortion over a wide range from low frequencies to high frequencies.
- Easy to design radiator fin.
- Built-in audio muting function.
- Built-in protectors.
  - a. Thermal protector
  - b. Overvoltage, surge voltage protector
  - c. Pin-to-pin short protector

### Package Dimensions

unit : mm

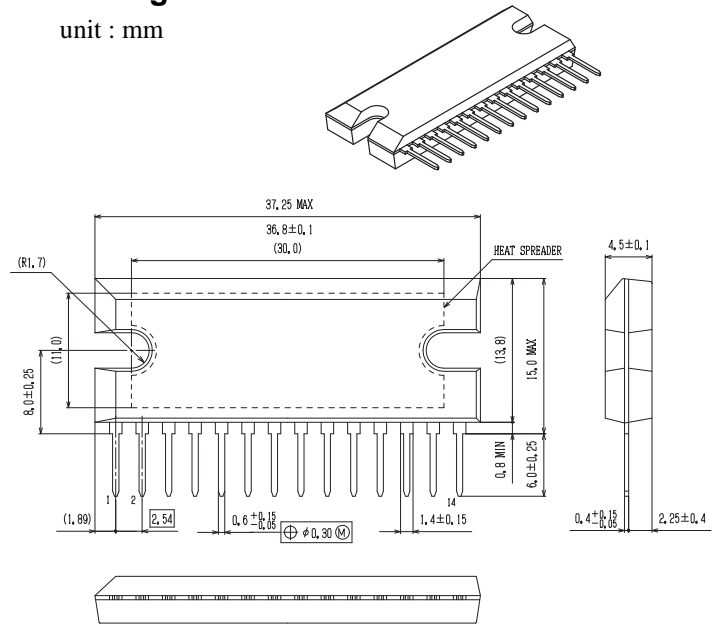

### Specifications

#### Absolute Maximum Ratings at Ta = 25°C

Parameter	Symbol	Conditions	Ratings	unit
Maximum supply voltage	V <sub>CC</sub> max1	Quiescent (t=30s)	25	V
	V <sub>CC</sub> max2	Operating	18	V
Surge supply voltage	V <sub>CC</sub> (surge)	t ≤ 0.2s	50	V
Allowable power dissipation	P <sub>d</sub> max	T <sub>c</sub> =75°C, See P <sub>d</sub> max – T <sub>a</sub> characteristic	15	W
Thermal resistance	θ <sub>j-c</sub>	Junction-to-case	3	°C/W
Operating temperature	T <sub>opr</sub>		-20 to +75	°C
Storage temperature	T <sub>stg</sub>		-40 to +150	°C

Stresses exceeding those listed in the Maximum Ratings table may damage the device. If any of these limits are exceeded, device functionality should not be assumed, damage may occur and reliability may be affected.

#### Recommended Operating Conditions at Ta = 25°C

Parameter	Symbol	Conditions	Ratings	unit
Supply voltage	V <sub>CC</sub>		13.2	V
Load resistance	R <sub>L</sub>	Stereo	2 to 8	Ω
		Bridge	4 to 8	Ω

Functional operation above the stresses listed in the Recommended Operating Ranges is not implied. Extended exposure to stresses beyond the Recommended Operating Ranges limits may affect device reliability.

### ORDERING INFORMATION

See detailed ordering and shipping information on page 13 of this data sheet.

# LA4440

**Operating Characteristics** at  $T_a = 25^\circ\text{C}$ ,  $V_{CC} = 13.2\text{V}$ ,  $R_L = 4\Omega$ ,  $f = 1\text{kHz}$ ,  $R_g = 600\Omega$ , with  $100 \times 100 \times 1.5\text{mm}^3$  Al fin,

See specified Test Circuit.

Parameter	Symbol	Conditions	Ratings			Unit
			min	typ	max	
Quiescent current	$I_{CCO}$			100	200	mA
Voltage gain	VG		49.5	51.5	53.5	dB
Output power	$P_O$	THD=10%, Stereo	5.0	6.0		W
		THD=10%, Bridge		19		W
Total harmonic distortion	THD	$P_O = 1\text{W}$		0.1	1.0	%
Input resistance	$r_i$			30k		$\Omega$
Output noise voltage	$V_{NO}$	$R_g = 0$		0.6	1.0	mV
		$R_g = 10\text{k}\Omega$		1.0	2.0	mV
Ripple rejection ratio	$R_r$	$V_R = 200\text{mV}$ , $f_R = 100\text{Hz}$ , $R_g = 0$		46		dB
Channel separation	Ch sep	$V_O = 0\text{dBm}$ , $R_g = 10\text{k}\Omega$	45	55		dB
Muting attenuation	ATT	$V_O = 0\text{dBm}$ , $V_M = 9\text{V}$		40		dB
Gain difference between channels	$\Delta\text{VG}$				2	dB

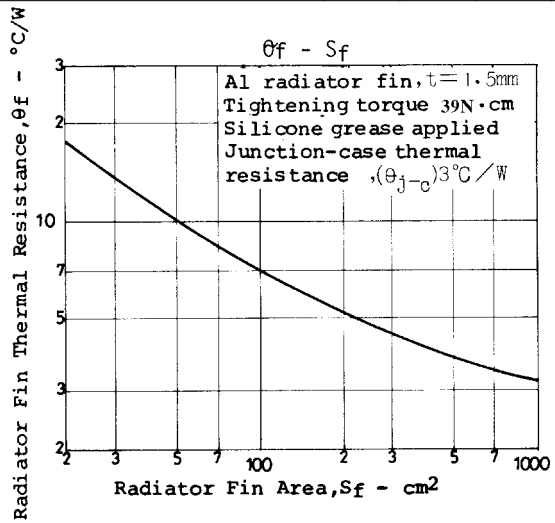
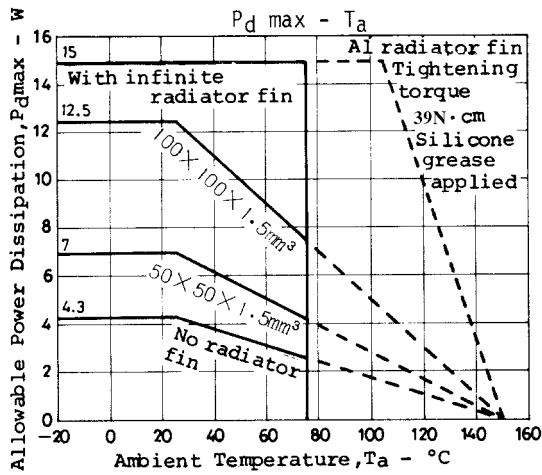

## Equivalent Circuit Block Diagram

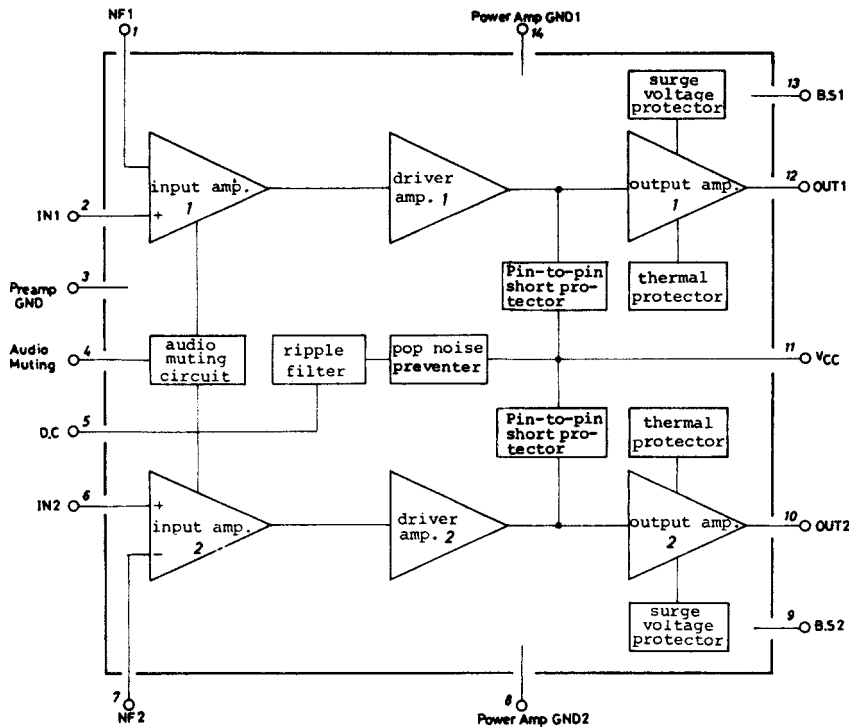

# LA4440

## Sample Application Circuit 1. Stereo use

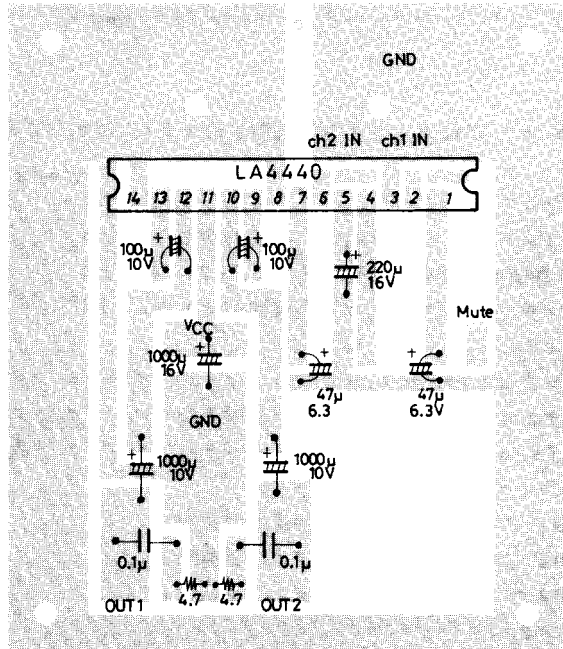
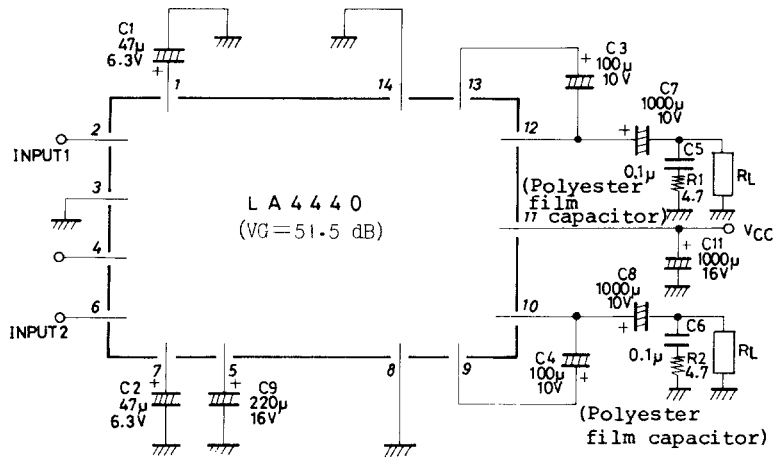

Sample printed circuit pattern for dual mode  
(Cu-foiled area) 60 x 70 mm<sup>2</sup>

## Sample Application Circuit 2. Bridge amplifier 1

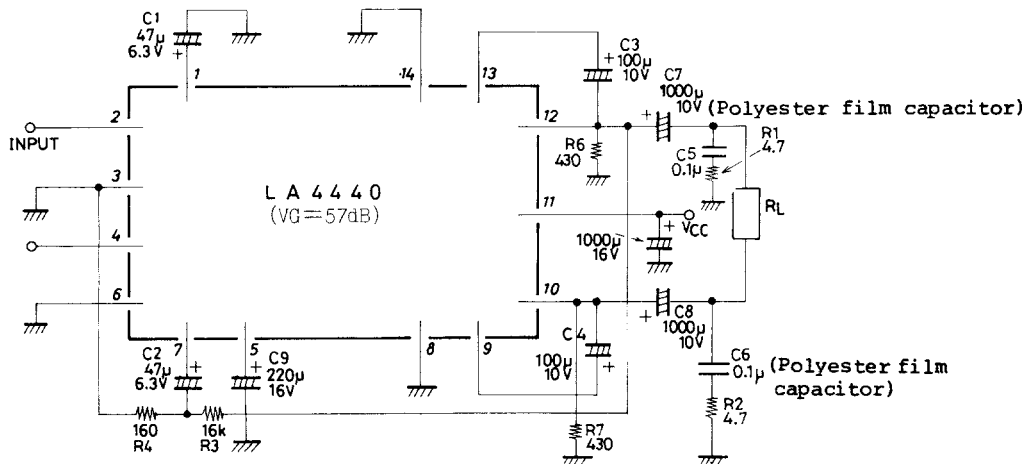

Sample Application Circuit 3. Bridge amplifier 2

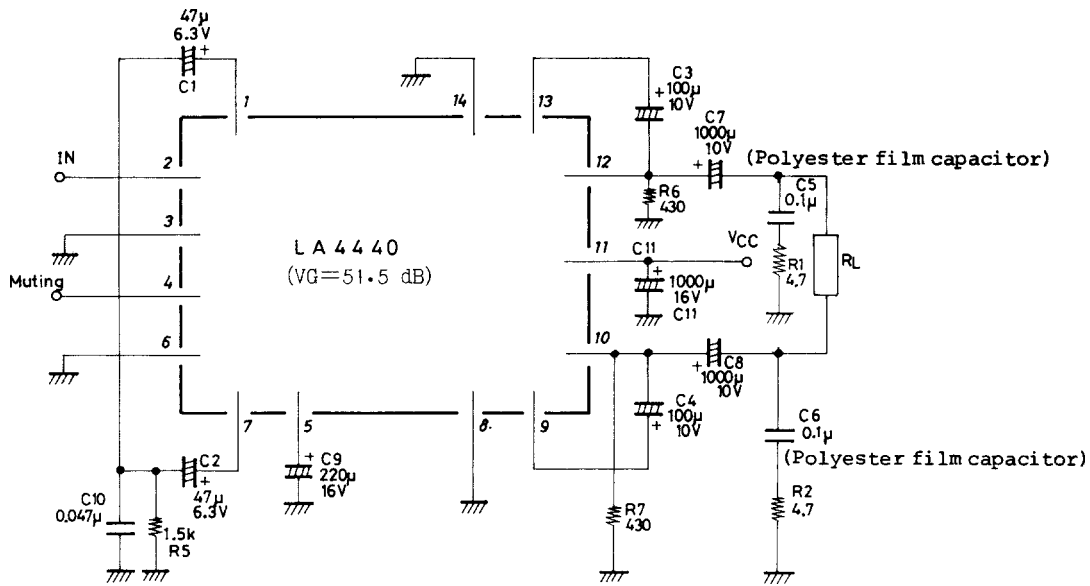

Description of External Parts

- C1 (C2) · Feedback capacitor : The low cutoff frequency depends on this capacitor. If the capacitance value is increased, the starting time is delayed.
- C3 (C4) · Bootstrap capacitor : If the capacitance value is decreased, the output at low frequencies goes lower.
- C5 (C6) · Oscillation preventing capacitor : Polyester film capacitor, being good in temperature characteristic, frequency characteristic, is used. The capacitance value can be reduced to 0.047µF depending on the stability of the board.
- C7 (C8) · Output capacitor : The low cutoff frequency depends on this capacitor. At the bridge amplifier mode, the output capacitor is generally connected.
- C9 · Decoupling capacitor :Used for the ripple filter. Since the rejection effect is saturated at a certain capacitance value, it is meaningless to increase the capacitance value more than required. This capacitor, being also used for the time constant of the muting circuit, affects the starting time.
- R1 (R2) · Filter resistor for preventing oscillation.
- R3 (R4) · Resistor for making input signal of inverting amplifier in Voltage Gain Adjust at Bridge Amplifier Mode (No. 1).
- R5 · Resistor for adjusting starting time in Voltage Gain Adjust at Bridge Amplifier Mode (No. 2)
- C10 · Capacitor for preventing oscillation in Voltage Gain Adjust at Bridge Amplifier Mode (No. 2)
- C11 · Power source capacitor.
- R6 (R7) · Used at bridge amplifier mode in order to increase discharge speed and to secure transient stability.

Features of IC System and Functions of Remaining Pins

- (a) Since the input circuit uses PNP transistors and the input potential is designed to be 0 bias, no input coupling capacitor is required and direct coupling is available. However, when slider contact noise caused by the variable resistor presents a problem, connect an capacitor in series with the input.
- (b) The open-loop voltage gain is lowered and the negative feedback amount is reduced for stabilization. An increase in distortion resulted from the reduced negative feedback amount is avoided by use of the built-in unique distortion reduction circuit, and thus distortion is kept at 0.1% (typ.).
- (c) A capacitor for oscillation compensation is contained as a means of reducing the number of external parts. The capacitance value is 35pF which determines high cutoff frequency  $f_H$  (-3dB point) of the amplifier ( $f_H \approx 20\text{kHz}$ ).
- (d) For preventing the IC from being damaged by a surge applied on the power line, an overvoltage protector is contained. Overvoltage setting is 25V. It is capable of withstanding up to 50V at giant pulse surge 200ms.
- (e) No damage occurs even when power is applied at a state where pins 10, 11, and 12 are short-circuited with solder bridge, etc.
- (f) To minimize the variations in voltage gain, feedback resistor  $R_{NF}$  is contained and voltage gain (51.5dB) is fixed.

Voltage Gain Adjust at Stereo Mode

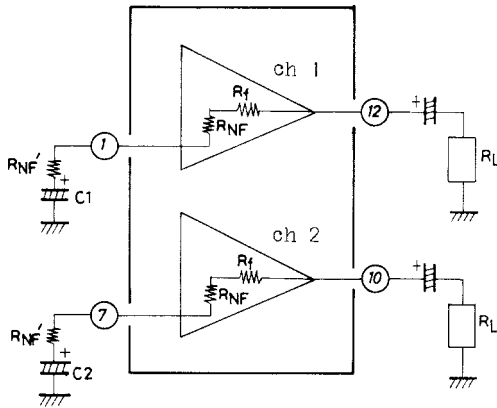

$R_{NF}=50\Omega$  (typ),  $R_f=20k\Omega$  (typ)  
At  $R_{NF}'=0$  (recommended VG)

$$VG=20\log \frac{VG}{R_{NF}} \text{ (dB)}$$

In case of using  $R_{NF}'$

$$VG=20\log \frac{R_f}{R_{NF}+R_{NF}'} \text{ (dB)}$$

Voltage Gain Adjust at Bridge Amplifier Mode (No. 1)

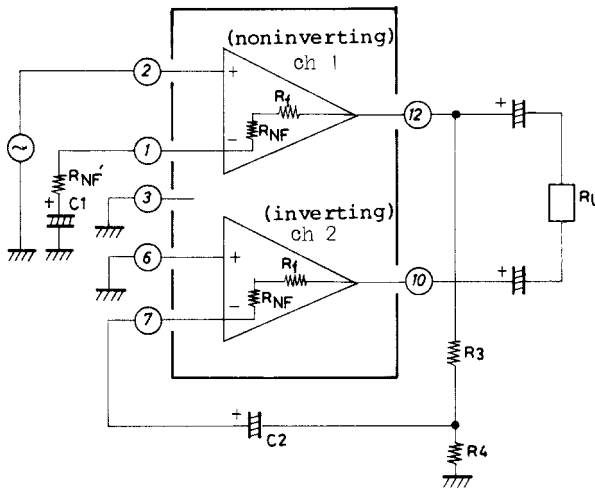

The bridge amplifier configuration is as shown left, in which ch1 and ch2 operate as noninverting amplifier and inverting amplifier respectively. The output of the noninverting amplifier divided by resistors  $R_3$ ,  $R_4$  is applied, as input, to the inverting amplifier. Since attenuation ( $R_4/R_3$ ) of the non-inverting amplifier output and amplification factor ( $R_f/R_4+R_{NF}$ ) of the inverting amplifier are fixed to be the same, signals of the same level and  $180^\circ$  out of phase with each other can be obtained at output pins (12) and (10). The total voltage gain is apparently higher than that of the noninverting amplifier by 6dB and is approximately calculated by the following formula.

$$VG=20\log \frac{R_f}{R_{NF}} + 6\text{dB}$$

In case of reducing the voltage gain,  $R_{NF}'$  is connected to the noninverting amplifier side only and the following formula is used.

$$VG=20\log \frac{R_f}{R_{NF}+R_{NF}'} + 6\text{dB}$$

Voltage Gain Adjust at Bridge Amplifier Mode (No. 2)

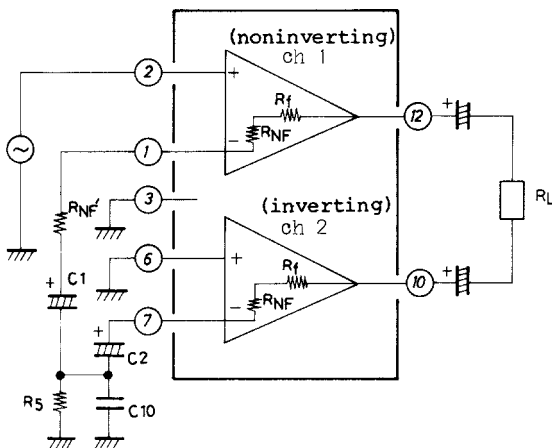

$$VG=20\log \frac{R_f}{\frac{R_{NF}+R_{NF}'}{2}} \text{ (dB)}$$

where  $(R_{NF}+R_{NF}') \ll R_5$

From this formula, it is seen that connecting  $R_{NF}'$  causes the voltage gain to be reduced at the modes of both stereo amplifier and bridge amplifier.

# LA4440

(g) In case of applying audio muting in each application circuit, the following circuit is used.

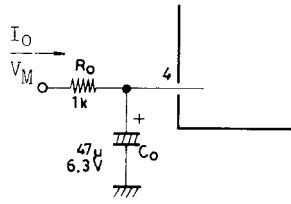

$6V \leq V_M \leq V_{CC}$   
 Recommended  $V_M = 9V$   
 $A_{TT} = 40dB$  ( $R_g = 600\Omega$ )

Flow-in current  $I_O$  is calculated by the following formula.

$$I_O = \frac{V_M - V_{BE}}{R_O}$$

In case of increasing the muting attenuation, resistor 5.6kΩ is connected in series with the input, and then the attenuation is made to be 55dB. Be careful that connecting an input capacitor causes pop noise to be increased at the time of application of AC muting. Increased  $R_O$ ,  $C_O$  make it possible to reduce the noise. In case of completely cutting off power IC, pin (5) is grounded, and then DC control is available and the attenuation is made to be  $\infty$ .

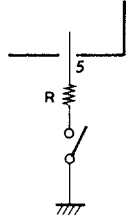

General-purpose switch

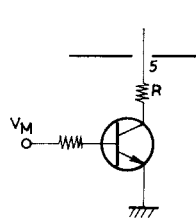

Transistor switch

Stereo :  $20\Omega \leq R \leq 100\Omega$   
 Bridge No.1 :  $20\Omega \leq R \leq 100\Omega$   
 Bridge No. 2 :  $0\Omega \leq R \leq 50\Omega$

## Pin Voltage (unit : V)

Pin No.	1	2	3	4	5	6	7	8	9	10	11	12	13	14
Function pin	CH1 NF	CH1 NF	Pre GND	AC Audio Muting	DC	CH2 IN	CH2 NF	CH2 Power GND	CH2 BS	CH2 OUT	$V_{CC}$	CH1 OUT	CH1 BS	CH1 Power GND
Pin Voltage at quiescent mode	1.4	0.03	0	0	13.0	0.03	1.4	0	11.9	6.8	13.2	6.8	11.9	0

## Proper Cares in Using IC

### · Maximum ratings

If the IC is used in the vicinity of the maximum ratings, even a slight variation in conditions may cause the maximum ratings to be exceeded, thereby leading to breakdown. Allow an ample margin of variation for supply voltage, etc. and use the IC in the range where the maximum ratings are not exceeded.

### · Printed circuit board

When making the board, refer to the sample printed circuit pattern and be careful that no feedback loop is formed between input and output.

### · Oscillation preventing capacitor

Normally, a polyester film capacitor is used for  $0.1\mu F + 4.7\Omega$ . The capacitance value can be reduced to  $0.047\mu F$  depending on the stability of the board.

### · Others

Connect the radiator fin of the package to GND.

# LA4440

## Characteristics at stereo amplifier mode

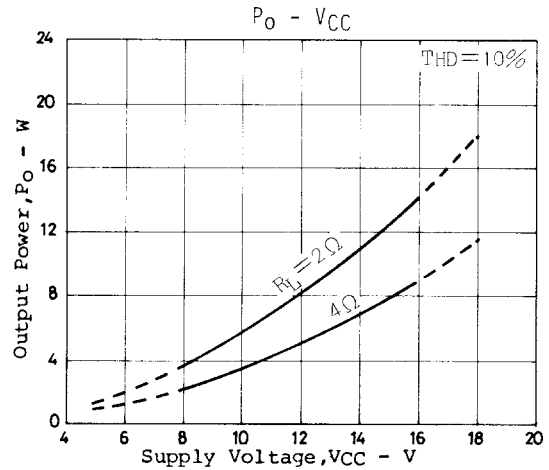
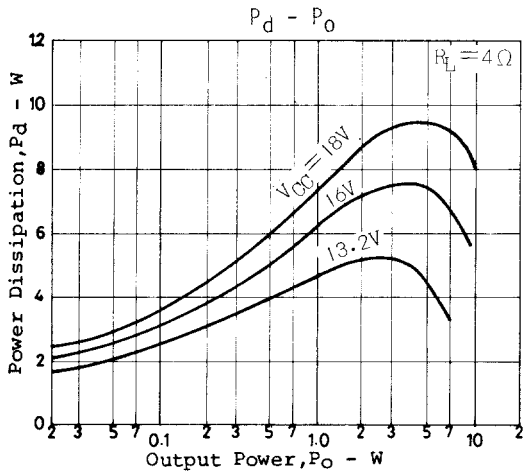
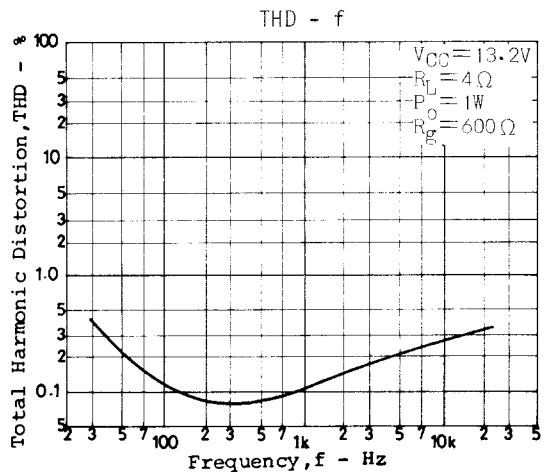
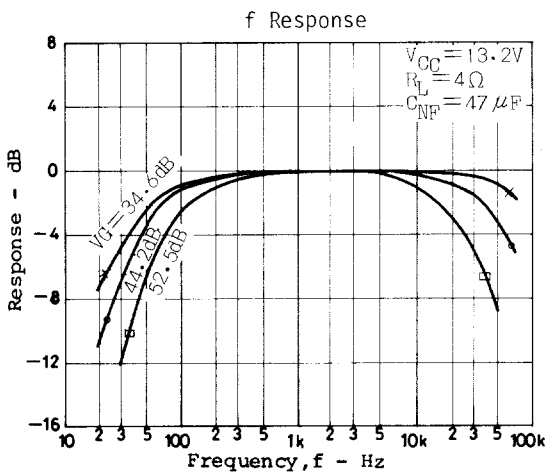
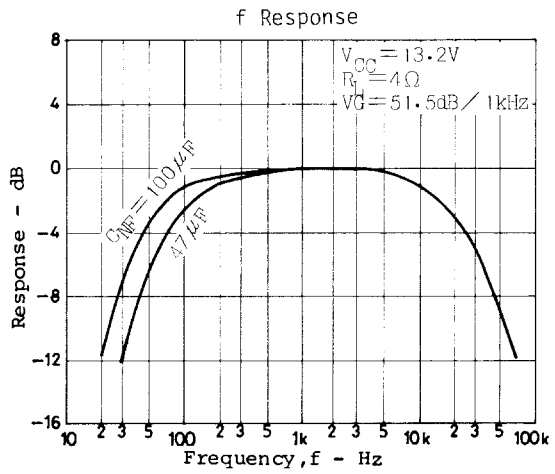
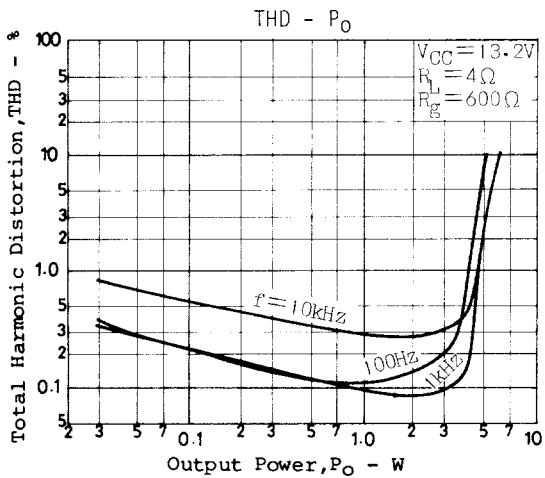
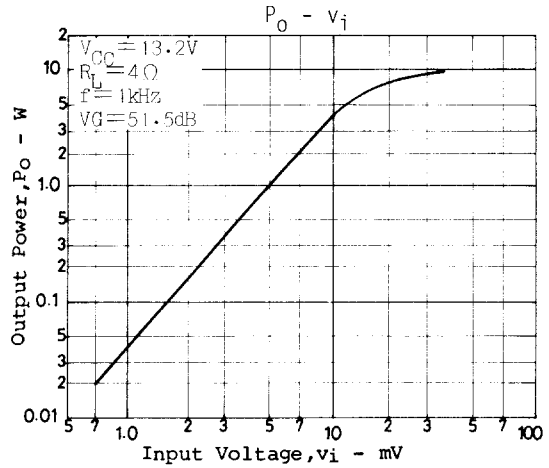
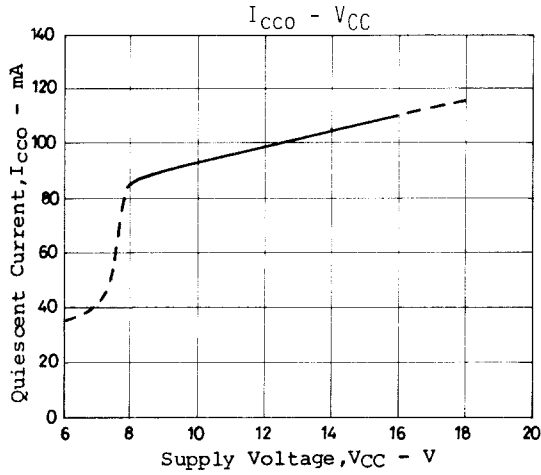

# LA4440

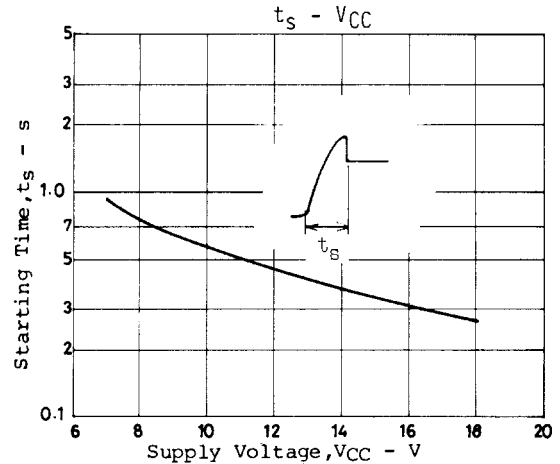
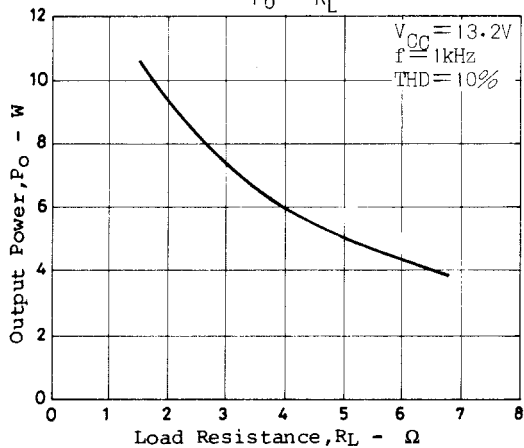
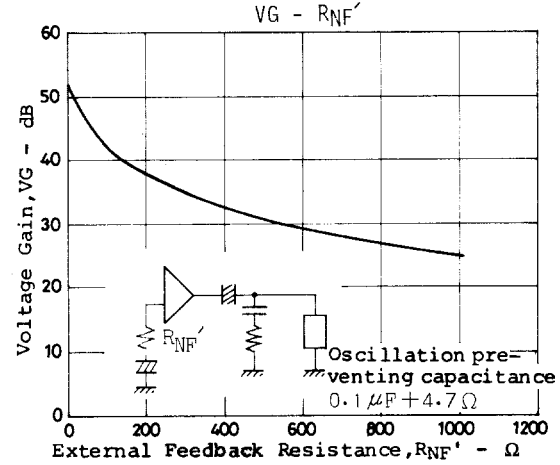
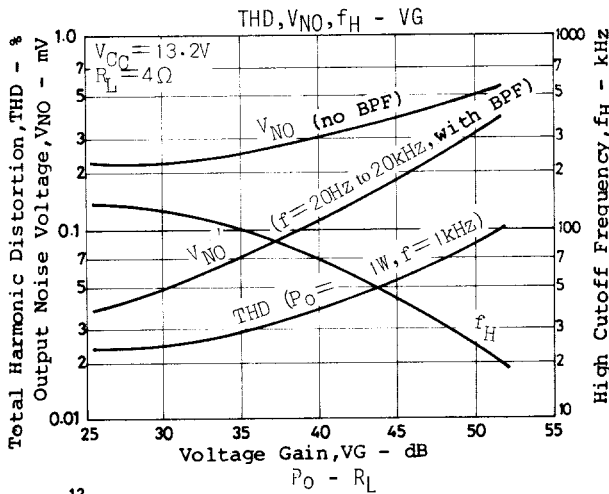
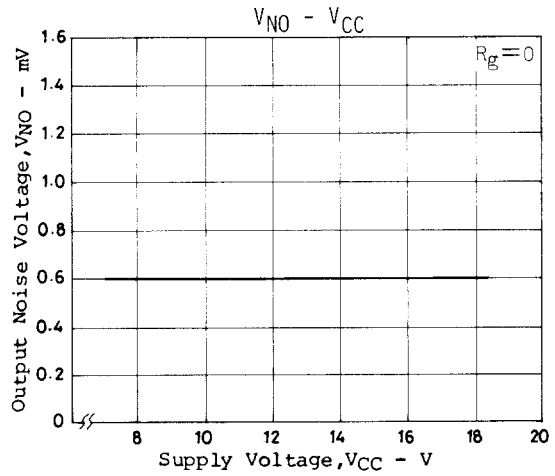
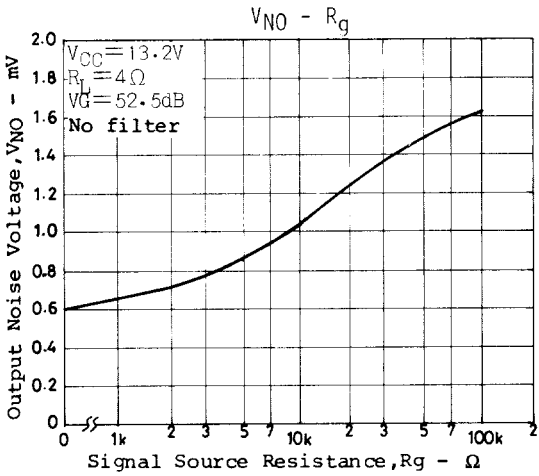
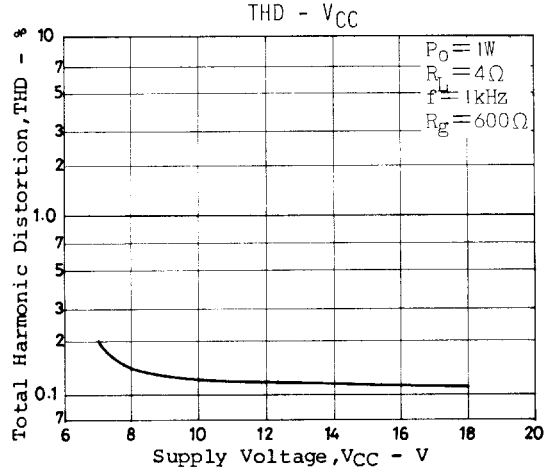
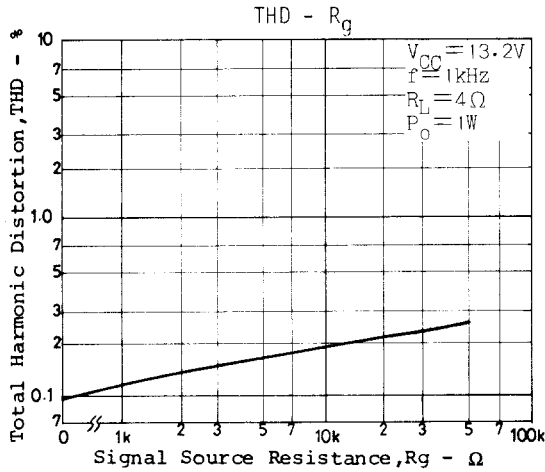



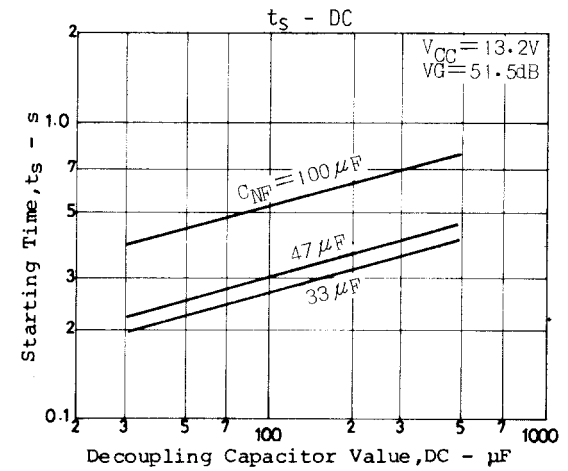
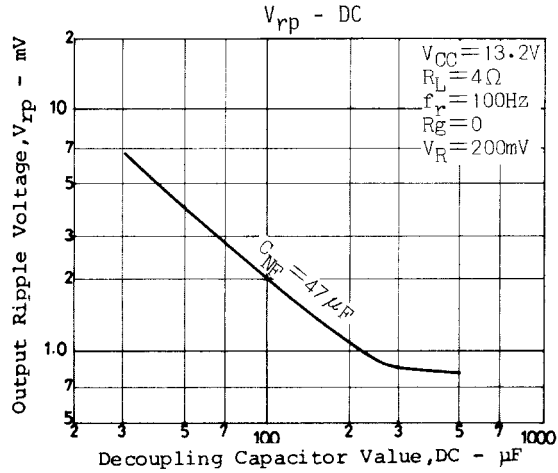
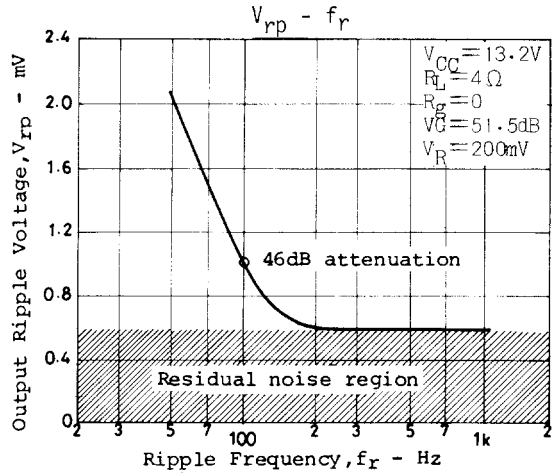
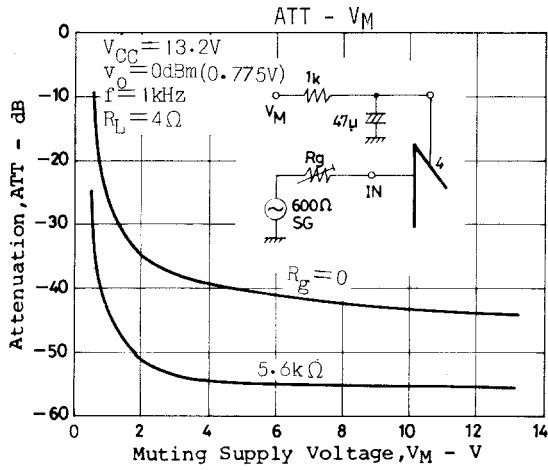

Characteristics at bridge amplifier mode No. 1

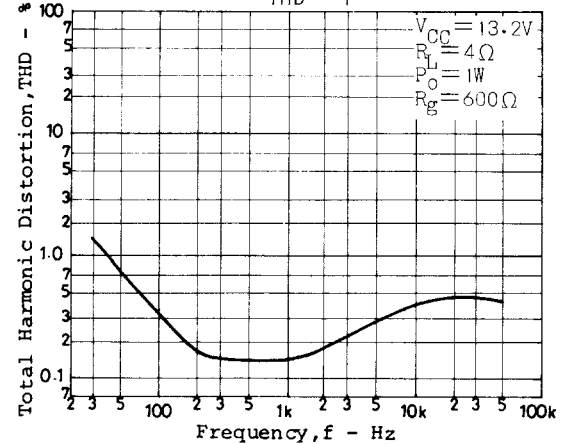
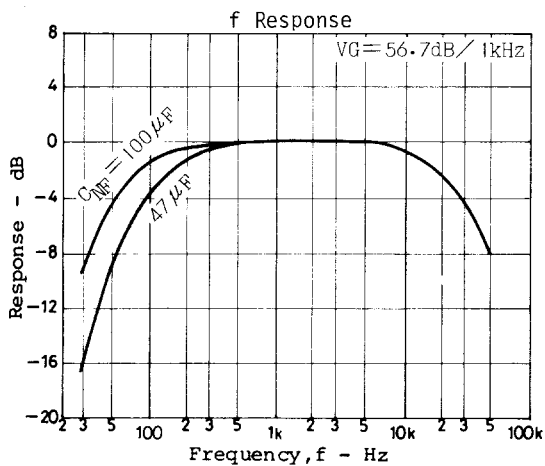
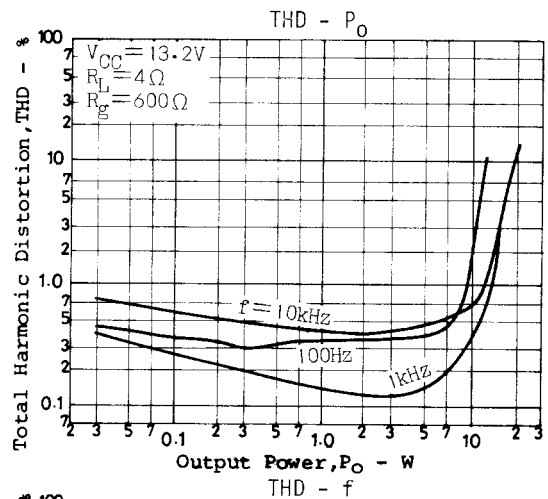
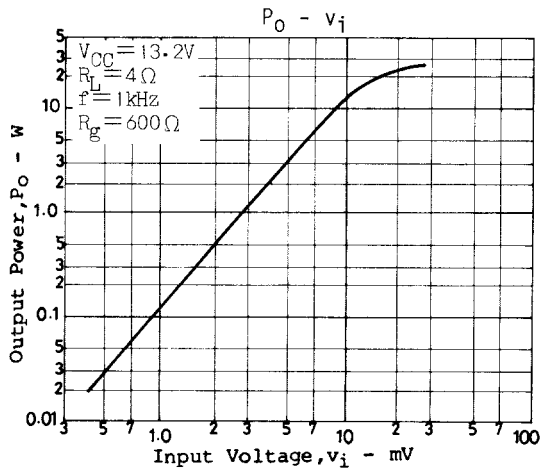

# LA4440

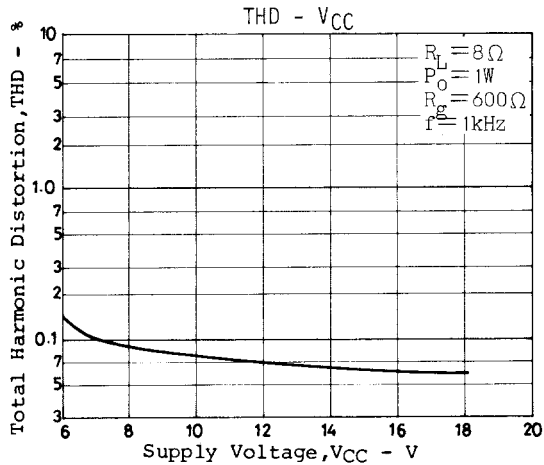
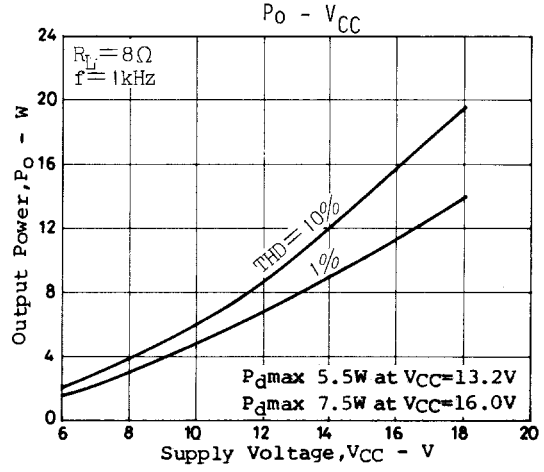
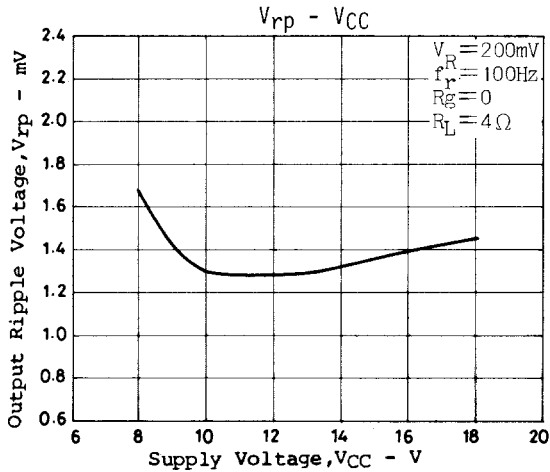
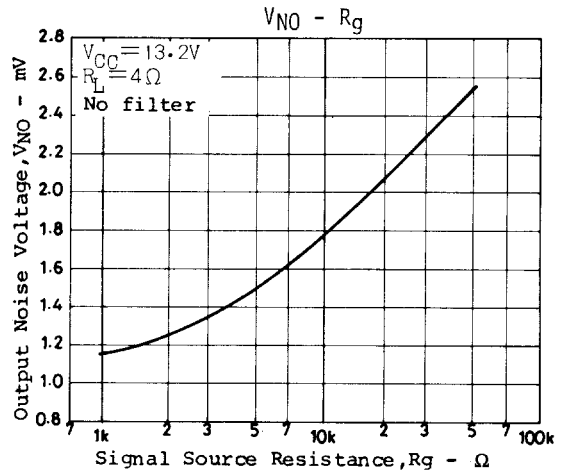
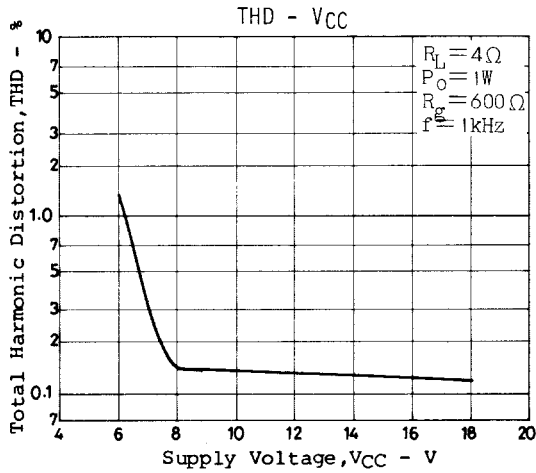
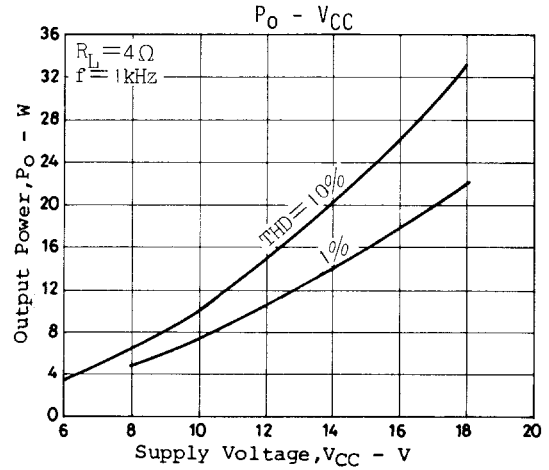
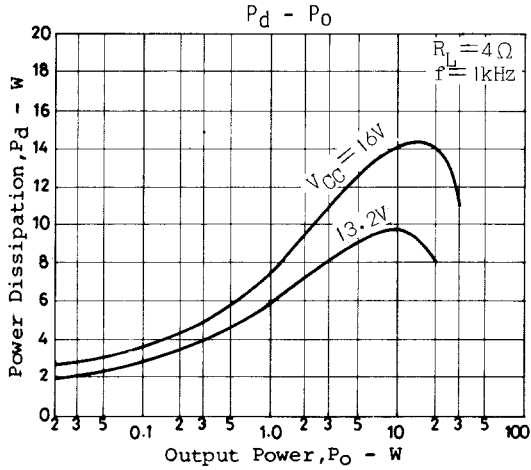

# LA4440

## Characteristics at bridge amplifier mode No. 2

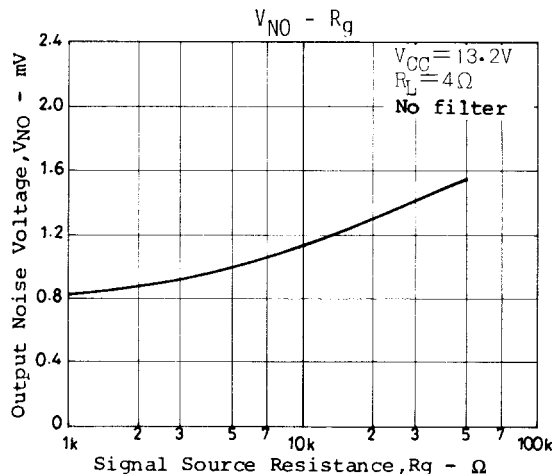
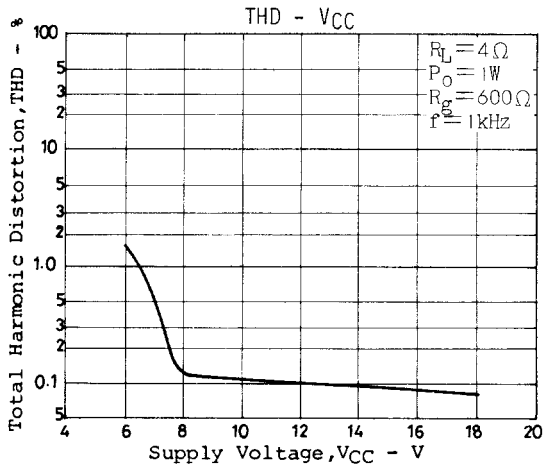
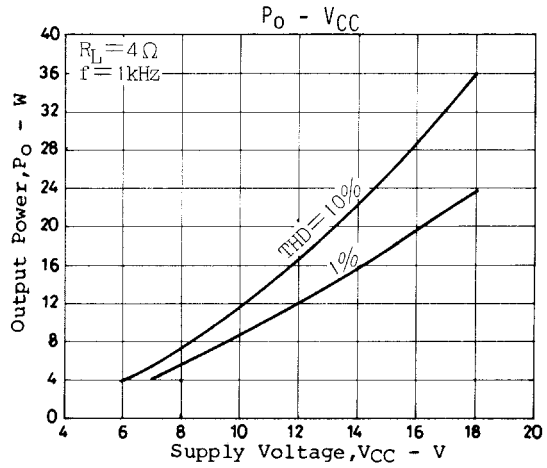
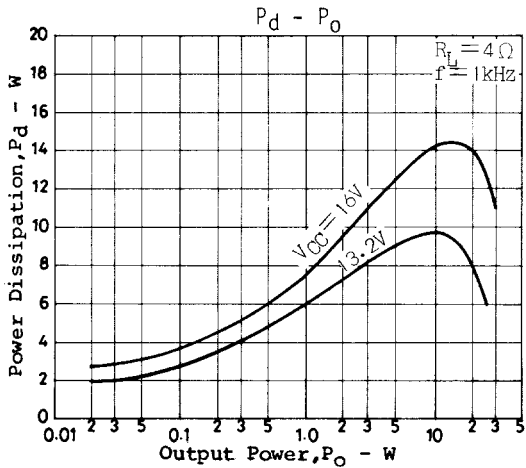
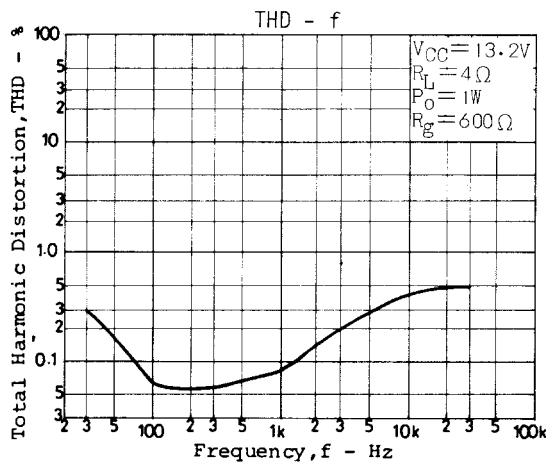
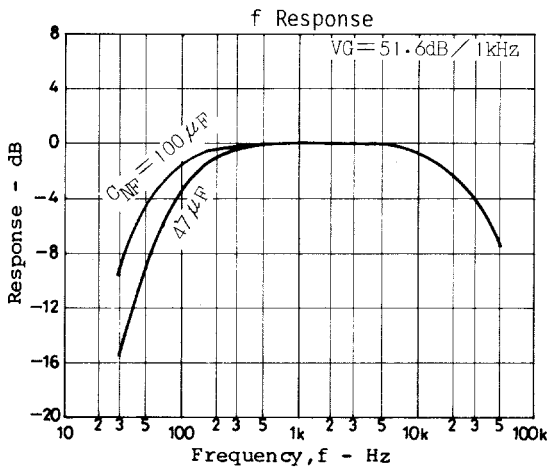
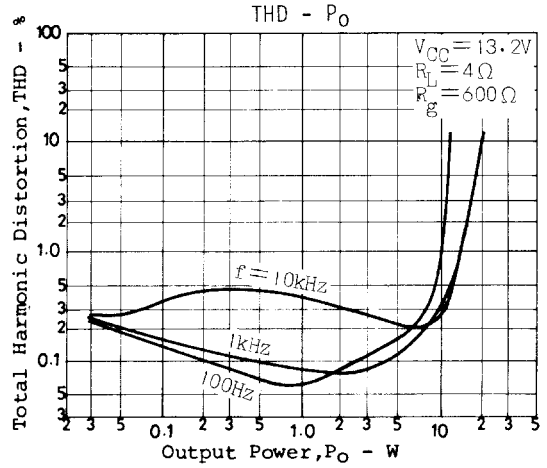
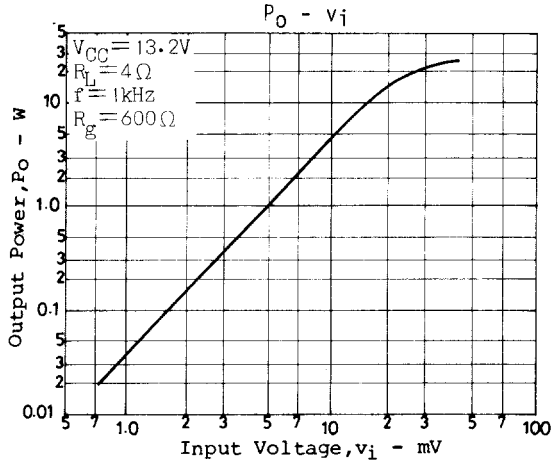

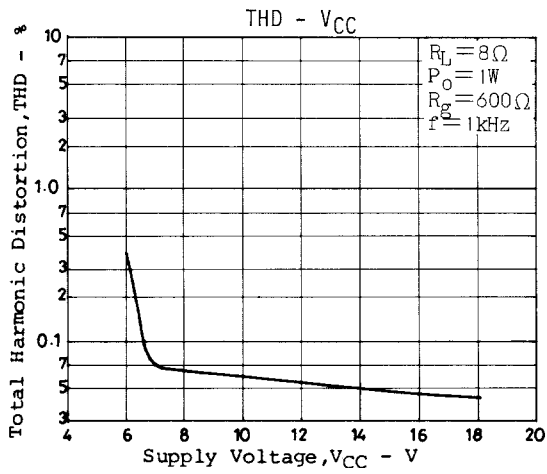
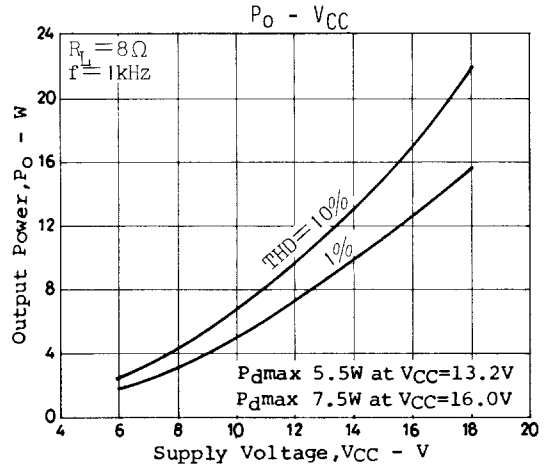
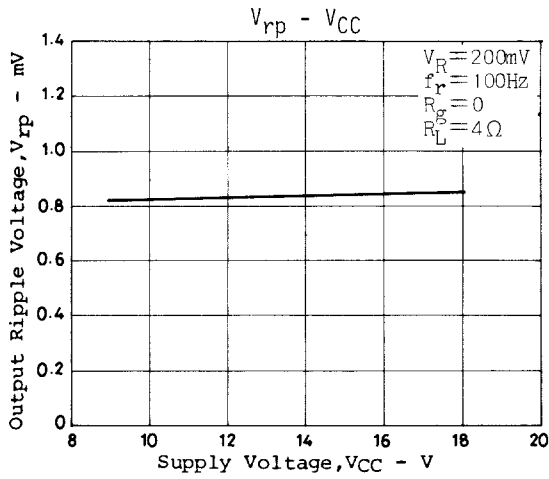

**Proper Cares in Mounging Radiator Fin**

1. The mounting torque is in the range of 39 to 59N · cm.
2. The distance between screw holes of the radiator fin must coincide with the distance between screw holes of the IC. With case outline dimensions L and R referred to, the screws must be tightened with the distance between them as close to each other as possible.

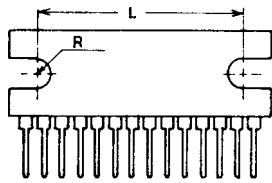

3. The screw to be used must have a head equivalent to the one of truss machine screw or binder machine screw defined by JIS. Washers must be also used to protect the IC case.
4. No foreign matter such as cutting particles shall exist between heat sink and radiator fin. When applying grease on the junction surface, it must be applied uniformly on the whole surface.
5. IC lead pins are soldered to the printed circuit board after the radiator fin is mounted on the IC.

**ORDERING INFORMATION**

Device	Package	Shipping (Qty / Packing)
LA4440J-K-E	SIP14H (Pb-Free)	15 / Fan-Fold

ON Semiconductor and the ON logo are registered trademarks of Semiconductor Components Industries, LLC (SCILLC). SCILLC owns the rights to a number of patents, trademarks, copyrights, trade secrets, and other intellectual property. A listing of SCILLC's product/patent coverage may be accessed at [www.onsemi.com/site/pdf/Patent-Marking.pdf](http://www.onsemi.com/site/pdf/Patent-Marking.pdf). SCILLC reserves the right to make changes without further notice to any products herein. SCILLC makes no warranty, representation or guarantee regarding the suitability of its products for any particular purpose, nor does SCILLC assume any liability arising out of the application or use of any product or circuit, and specifically disclaims any and all liability, including without limitation special, consequential or incidental damages. "Typical" parameters which may be provided in SCILLC data sheets and/or specifications can and do vary in different applications and actual performance may vary over time. All operating parameters, including "Typicals" must be validated for each customer application by customer's technical experts. SCILLC does not convey any license under its patent rights nor the rights of others. SCILLC products are not designed, intended, or authorized for use as components in systems intended for surgical implant into the body, or other applications intended to support or sustain life, or for any other application in which the failure of the SCILLC product could create a situation where personal injury or death may occur. Should Buyer purchase or use SCILLC products for any such unintended or unauthorized application, Buyer shall indemnify and hold SCILLC and its officers, employees, subsidiaries, affiliates, and distributors harmless against all claims, costs, damages, and expenses, and reasonable attorney fees arising out of, directly or indirectly, any claim of personal injury or death associated with such unintended or unauthorized use, even if such claim alleges that SCILLC was negligent regarding the design or manufacture of the part. SCILLC is an Equal Opportunity/Affirmative Action Employer. This literature is subject to all applicable copyright laws and is not for resale in any manner.